

VariTrans P 29000

Compact high voltage transducers with VariPower broad-range power supply and genuine calibrated range selection.

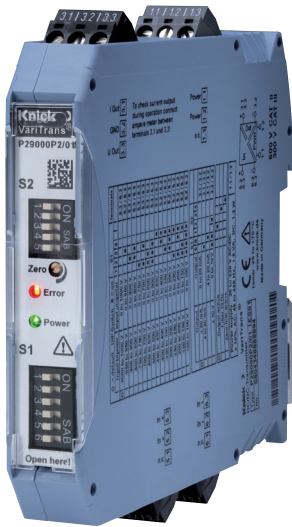

The Task

When it comes to taking measurements on power electronics, unipolar or bipolar voltage signals ranging from 20 mV to 1000 V must be galvanically isolated and converted to standard ± 20 mA, ± 10 V, or 4 ... 20 mA output signals.

The Problems

Room in the enclosure is limited and expensive. Therefore great value is placed on the miniaturization of automation components. And high safety requirements with regard to the protection of persons and systems must also be met.

The Solution

The VariTrans P 29000 isolator series is designed specifically to measure voltages up to 1000 V AC/DC. The test voltage is 5.4 kV AC. Protection against electric shock is achieved through protective separation according to EN 61140 between input and output and power supply up to 600 V AC/DC.

Compact automation solutions can be implemented thanks to the 17.5 mm modular housing and operation at temperatures up to 70 °C.

The Housing

With a width of only 17.5 mm, the modular housings of the P 29000 series strike an optimum balance between compact design and safety. The relevant safety standards are reliably met.

The device features test jacks which enable direct measurement of output current and voltage without having to open the output circuit.

The Advantages

The measuring ranges of the VariTrans P 29000 are adjusted via DIP switches on the front side of the modular housing. The switch coding is printed on the housing. Calibrated switching is controlled by a microcontroller. This makes for very easy configuration requiring neither calibrators nor other measuring equipment. The user can select from up to 192 switchable calibrated ranges.

In addition to the active current or voltage output, a passive current output allows for connection to active PLC inputs. LEDs indicate proper functioning or possible fault conditions, such as exceeding of the allowable load voltage at the output. The simple implementation of special measuring ranges supports solutions tailored to your application. An optional Rangelimit function lets you set lower and upper output limits on the transducers. The output can be inverted by the user. A connectable potentiometer enables zero point adjustment of up to 5 % on the measuring section to compensate for sensor drift, for example. The VariTrans P 29000 itself requires no manual zero point adjustment.

VariTrans P 29000

The Technology

In the VariTrans P 29000 series, the circuit design and device construction ensure excellent transmission quality which is reflected in the zero stability, linearity, long-term stability, frequency response and immunity to interference.

The devices' high cutoff frequency guarantees distortion-free signal conversion. The output signal follows fast changes in the input signal almost without delay.



Facts and Features

- **Universal usability**
20 mV to 1000 V input
- **Working voltages**
Up to 1000 V AC/DC basic insulation
- **Protective separation**
according to EN 61140 – protection of the maintenance staff and downstream devices against excessively high voltages up to 600 V AC/DC
- **Test voltage**
5.4 kV AC between input and output / power supply 4.3 kV AC between power supply and output
- **Excellent transmission properties**
 - Gain error 0.2 %
 - Cutoff frequency > 10 kHz
 - Response time T99 < 200 µs
 - High output power:
12 V (current output),
10 mA (voltage output)
- **High immunity to transient common-mode interference**
T-CMR >100 dB
- **Tremendous flexibility provided by**
calibrated range selection; reduced number of product variants minimizes inventory costs
- **Optional sensor adjustment**
with zero point potentiometer
- **Worldwide usability**
with VariPower broad-range power supply 20 V to 230 V AC/DC ±10 %; reliable function even with unstable supply
- **No damage**
in the case of erroneous power connection
- **Passive current output**
additional passive current output allows for connection of active PLC inputs
- **Switchable inversion**
of the output
- **RangeLimit**
adjustable lower or upper limit at output; optional
- **Test jacks**
for measuring output current and voltage
- **Low space requirement**
in enclosure with only 17.5 mm wide modular housing
- **Low-cost assembly**
Quick mounting, convenient connection of the power supply via DIN rail bus connectors (in the case of 24 V DC supply)
- **5-year warranty**



Measuring Ranges

VariTrans P 29000 – Standard Device Ranges

Bipolar input	Active output	Passive output	Unipolar input	Active output	Passive output
-1000 ... 1000 V	-20 ... 20 mA	4 ... 20 mA	0 ... 1000 V	0 ... 20 mA	4 ... 20 mA
-950 ... 950 V	20 ... -20 mA		0 ... 950 V	0 ... -20 mA	
-900 ... 900 V	4 ... 20 mA		0 ... 900 V	4 ... 20 mA	
-800 ... 800 V	-10 ... 10 V		0 ... 800 V	0 ... -10 V	
-750 ... 750 V	10 ... -10 V		0 ... 750 V	0 ... 10 V	
-700 ... 700 V			0 ... 700 V		
-600 ... 600 V			0 ... 600 V		
-500 ... 500 V			0 ... 500 V		
-450 ... 450 V			0 ... 450 V		
-400 ... 400 V			0 ... 400 V		
-350 ... 350 V			0 ... 350 V		
-300 ... 300 V			0 ... 300 V		
-250 ... 250 V			0 ... 250 V		
-200 ... 200 V			0 ... 200 V		
-150 ... 150 V			0 ... 150 V		
-100 ... 100 V			0 ... 100 V		

VariTrans P 29001 – Standard Device Ranges

Bipolar input	Active output	Passive output	Unipolar input	Active output	Passive output
-100 ... 100 V	-20 ... 20 mA	4 ... 20 mA	0 ... 100 V	0 ... 20 mA	4 ... 20 mA
-80 ... 80 V	20 ... -20 mA		0 ... 80 V	0 ... -20 mA	
-60 ... 60 V	4 ... 20 mA		0 ... 60 V	4 ... 20 mA	
-50 ... 50 V	-10 ... 10 V		0 ... 50 V	0 ... -10 V	
-30 ... 30 V	10 ... -10 V		0 ... 30 V	0 ... 10 V	
-20 ... 20 V			0 ... 20 V		
-10 ... 10 V			0 ... 10 V		
-5 ... 5 V			0 ... 5 V		
-300 ... 300 mV			0 ... 300 mV		
-200 ... 200 mV			0 ... 200 mV		
-150 ... 150 mV			0 ... 150 mV		
-120 ... 120 mV			0 ... 120 mV		
-100 ... 100 mV			0 ... 100 mV		
-90 ... 90 mV			0 ... 90 mV		
-60 ... 60 mV			0 ... 60 mV		
-30 ... 30 mV			0 ... 30 mV		

VariTrans P 29000

Product Line

VariTrans P 29000 P2

Order no.	P 29000 P2 /	0	□	-	□	□	□	□
24 V	Standard device	0						
Broad range	Standard device	1						
Variant	Customer-specific				n	n	n	n

VariTrans P 29001 P2

Order no.	P 29001 P2 /	0	□	-	□	□	□	□
24 V	Standard device	0						
Broad-range	Standard device	1						
Variant	Customer-specific				n	n	n	n

Special versions

Shunt monitoring (for P29001 only)	Monitoring the input circuit: If an input is open (lines to shunt resistor broken), the output emits an error signal ≥ 25 mA.
---------------------------------------	--

RangeLimit	A lower or upper limit value can be specified for the output range.
------------	---

All special versions apply to all measuring ranges.

Accessories

		Order no.
IsoPower A 20900	Power supply	A 20900 H4
DIN rail bus connector	for tapping of supply voltage (on right side of IsoPower A 20900, 2 units required)	ZU 0678
Supply terminal	for 24 V DC, dual supply	ZU 0677

Specifications

Input data

Input range	Max. ± 1000 V DC	
Overload capacity (permanent)	0 ... 1 V	max. ± 30 V
	1 ... 100 V	max. ± 500 V
	100 ... 500 V	max. ± 600 V
	500 ... 1000 V	max. ± 1200 V
Input resistance	0 ... 1 V	approx. 10 kohms
	1 ... 100 V	approx. 400 kohms
	100 ... 500 V	approx. 2 Mohms
	500 ... 1000 V	approx. 4 Mohms
Shunt break detection (opt.)	< 300 μ A	

Specifications (continued)

Output data

Active output	0/4 ... 20 mA or 0 ... 10 V, resp., or -20 ... +20 mA or -10 ... +10 V, resp.
Passive output	4 ... 20 mA
Offset	Default ±150 %
Max. load with: current voltage	Active: ≤ 12 V (600 ohms at 20 mA) Passive: 12 ... 26 V ≤ 10 mA (1 kohm at 10 V)
Overload range	Current output: > 22 mA (26 V) Voltage output: < 15 V
Overload capacity with externally applied voltage	± 30 V
Offset adjustment range	± 5 %
Residual ripple	< 10 mV _{rms}
Voltage drop when measuring output current at test jacks 3.1 and 3.3	Max. 150 mV

Transmission behavior

Gain error	Input ≤ 1 V ≤ 0.1 % meas. val. Input > 1 V ≤ 0.2 % meas. val.
Offset	≤ 0.1 % full scale
Linear control range	-5 % to 105 % of input span
Overload indication	Red LED on front
Load error indication	Red LED on front
Response time t_{99}	< 200 ms or < 200 μs for cutoff frequency 10 Hz or 10 kHz
Cutoff frequency	10 Hz or 10 kHz
Common-mode rejection ratio	Input range ≤ 1 V CMRR ¹⁾ approx. 150 dB (DC/AC: 50 Hz) T-CMRR ²⁾ approx. 100 dB (1000 V, tr = 1 μs)
Temperature influence ³⁾	Input ≤ 1 V ≤ 50 % full scale Input > 1 V ≤ 80 % full scale

Power supply

Power supply	P2900XP2/00 24 V DC +/-25 % P2900XP2/01 20 ... 230 V AC/DC +/-10 %; AC: 45 Hz to 440 Hz
Power consumption	1.5 W

VariTrans P 29000

Specifications (continued)

Isolation

Galvanic isolation	3-port isolation between input, output, and power supply
Test voltage	5.4 kV AC across input and output / power supply 4.3 kV AC across power supply and output
Basic insulation acc. to EN 61010-1:2001 for circuits of CAT II and CAT III	Working voltage CAT II: 1000 V AC/DC CAT III: 1000 V AC/DC
Reinforced insulation acc. to EN 61010-1:2001 for circuits of CAT II and CAT III	Working voltage CAT II: 600 V AC/DC CAT III: 300 V AC/DC
Insulation according to standards UL 508 and C22.2 No. 14 – 2010	Working voltage CAT III: 600 V AC/DC

Standards and approvals

EMC ⁴⁾	Product standard EN 61326-1 Emitted interference: Class B Immunity to interference: Industrial environment
USA / Canada, UL.	cULus Listed, Industrial Control Equipment. File: E220033, Standard: ANSI/UL 508, Standard Canada: C22.2 No. 14 - 2010
RoHS conformity	According to directive 2011/65/EU

Further data

MTBF ⁵⁾	158 years
Ambient temperature	Operation: –25 ... +70 °C (min. start temp.: –40 °C) Operation with passive output: –25 ... +60 °C Transport and storage: –40 ... +85 °C
Ambient conditions	Indoor use ⁶⁾ Relative humidity: 5 ... 95 %, no condensation Max. altitude 2000 m (air pressure: 790 ... 1060 hPa (at p ₀ =1013 hPa) ⁷⁾
Design	Modular housing with screw terminals Housing width: 17.5 mm
Connection	Conductor cross section max. 2.5 mm ² , AWG 20-12
Tightening torque	0.6 Nm
Diameter of the test jacks	2.1 mm
Ingress protection	Housing: IP 40, terminals: IP 20
Mounting	With snap-on mounting for 35 mm DIN rail according to EN 60715
Weight	Approx. 120 g
Accessories	ZU 0678 DIN rail bus connector A20900H4 power supply ZU 0677 supply terminal

¹⁾ Common-mode rejection ratio = differential voltage gain : common-mode voltage gain

²⁾ Transient common-mode rejection ratio = differential DC gain : common-mode transient peak value gain

³⁾ Reference temperature for TC specifications = 23 °C, average TC

⁴⁾ Slight deviations are possible while there is interference

⁵⁾ Mean time between failures – according to EN 61709 (SN 29500). Conditions: stationary operation in well-kept rooms, average ambient temperature 40 °C, no ventilation, continuous operation

⁶⁾ Closed, weather-protected operating areas (stationary operation), water or wind-driven precipitation (rain, snow, hail, etc.) excluded

⁷⁾ Lower air pressure reduces the allowable working voltages.

Characteristic Curves

Normal characteristic with adjustable RangeLimit (min) and adjustable offset

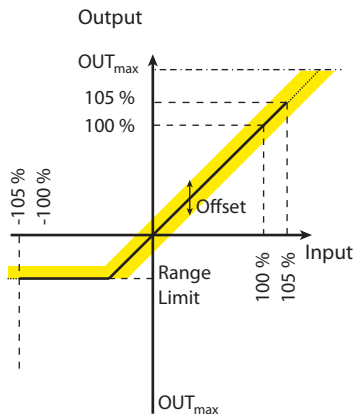

Inverting characteristic with adjustable RangeLimit (max) and adjustable offset

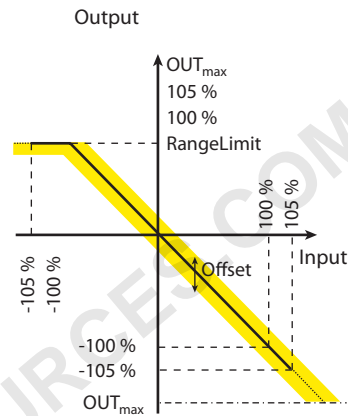

Typical Wirings

Typical Wirings (Input)

VariTrans P 29000:
500 ... 1000 V
VariTrans P 29001:
0 ... 100 V

VariTrans P 29000:
100 ... 500 V
VariTrans P 29001:
0 ... 300 mV

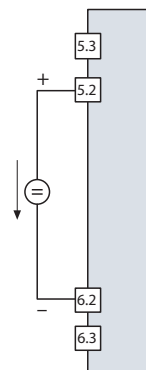
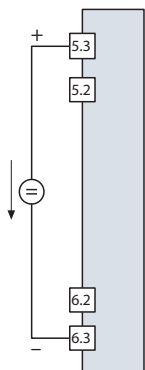

Typical Wirings (Output)

Voltage output with opt. measurement

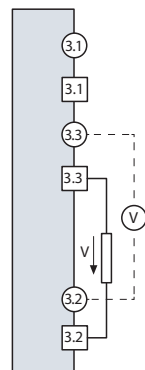

Current output, active, with opt. measurement

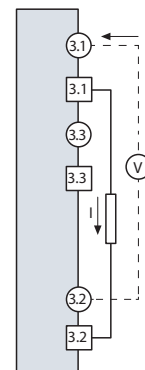

Current output, passive, with opt. measurement

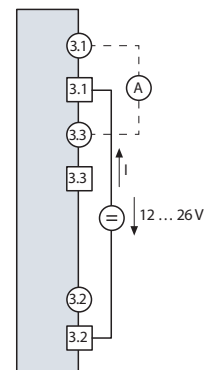

VariTrans P 29000

Block Diagram

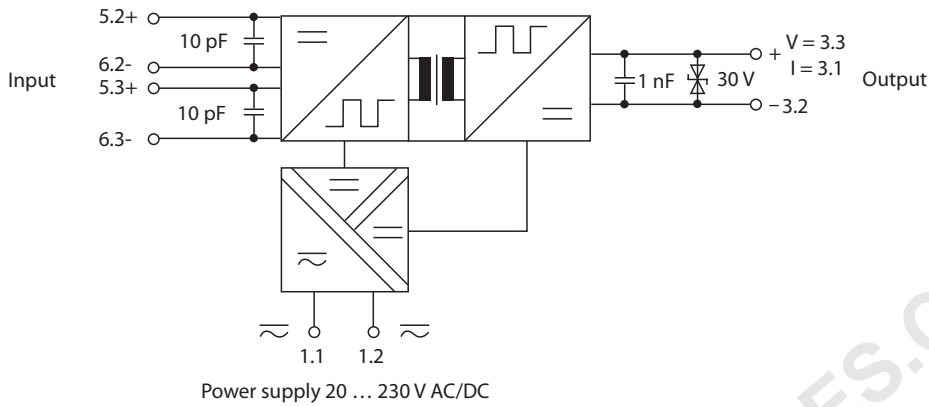

Dimension Drawing and Terminal Assignments

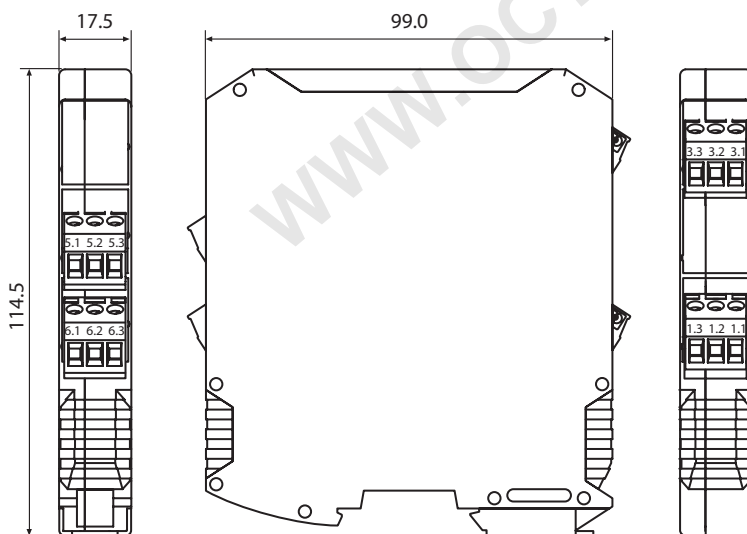

1.1	Power supply	1.2	Power supply	1.3	Not connected
3.1	Current output (passive/active)	3.2	GND output	3.3	Voltage output
5.1	Not connected	5.2	Positive input	5.3	Positive input
6.1	Not connected	6.2	Negative input	6.3	Negative input

All dimensions in mm